



**TECHDOCS**

# **ION 5200 Hardware Reference**

---

## Contact Information

Corporate Headquarters:

Palo Alto Networks

3000 Tannery Way

Santa Clara, CA 95054

[www.paloaltonetworks.com/company/contact-support](http://www.paloaltonetworks.com/company/contact-support)

## About the Documentation

- For the most recent version of this guide or for access to related documentation, visit the Technical Documentation portal [docs.paloaltonetworks.com](http://docs.paloaltonetworks.com).
- To search for a specific topic, go to our search page [docs.paloaltonetworks.com/search.html](http://docs.paloaltonetworks.com/search.html).
- Have feedback or questions for us? Leave a comment on any page in the portal, or write to us at [documentation@paloaltonetworks.com](mailto:documentation@paloaltonetworks.com).

## Copyright

Palo Alto Networks, Inc.

[www.paloaltonetworks.com](http://www.paloaltonetworks.com)

© 2021-2022 Palo Alto Networks, Inc. Palo Alto Networks is a registered trademark of Palo Alto Networks. A list of our trademarks can be found at [www.paloaltonetworks.com/company/trademarks.html](http://www.paloaltonetworks.com/company/trademarks.html). All other marks mentioned herein may be trademarks of their respective companies.

## Last Revised

September 2, 2022

---

# Table of Contents

<b>Before You Begin.....</b>	<b>5</b>
Tamper Proof Statement.....	6
Third-Party Component Support.....	7
Product Safety Warnings.....	8
<b>ION 5200 Overview.....</b>	<b>11</b>
ION 5200 Hardware Specifications.....	12
ION 5200 Front Panel.....	14
ION 5200 Back Panel.....	15
Installation Kit Components.....	16
ION 5200 LEDs.....	17
ION 5200 Compliance Statement.....	19
Power on the ION.....	24
Restart the ION 5200.....	24
Shut Down the ION 5200.....	24
<b>Install the ION 5200.....</b>	<b>25</b>
Install the ION 5200 Using the Four-Post Rack Mount Kit.....	26



# Before You Begin

Learn about the product safety and compliance before you begin:

- [Tamper Proof Statement](#)
- [Product Safety Warnings](#)
- [Third-Party Component Support](#)

## Tamper Proof Statement

To ensure that products purchased from Palo Alto Networks were not tampered with during shipping, verify the following upon receipt of each product:

- The tracking number provided to you electronically when ordering the product matches the tracking number that is physically labeled on the box or crate.
- The integrity of the tamper-proof tape used to seal the box or crate is not compromised.
- The integrity of the warranty label on the firewall or appliance is not compromised.

## Third-Party Component Support

Before you consider installing third-party hardware, read the [Palo Alto Networks Third-Party Component Support](#) statement.

## Product Safety Warnings

To avoid personal injury or death for yourself and others and to avoid damage to your Palo Alto Networks hardware, be sure you understand and prepare for the following warnings before you install or service the hardware. You will also see warning messages throughout the hardware reference where potential hazards exist.



*All Palo Alto Networks products with laser-based optical interfaces comply with 21 CFR 1040.10 and 1040.11.*

**The following safety warnings apply to all Palo Alto Networks firewalls and appliances, unless a specific hardware model is specified.**

- When installing or servicing a Palo Alto Networks firewall or appliance hardware component that has exposed circuits, ensure that you wear an electrostatic discharge (ESD) strap. Before handling the component, make sure the metal contact on the wrist strap is touching your skin and that the other end of the strap is connected to earth ground.

**French Translation:** Lorsque vous installez ou que vous intervenez sur un composant matériel de pare-feu ou de dispositif Palo Alto Networks qui présente des circuits exposés, veillez à porter un bracelet antistatique. Avant de manipuler le composant, vérifiez que le contact métallique du bracelet antistatique est en contact avec votre peau et que l'autre extrémité du bracelet est raccordée à la terre.

- Use grounded and shielded Ethernet cables (when applicable) to ensure agency compliance with electromagnetic compliance (EMC) regulations.

**French Translation:** Des câbles Ethernet blindés reliés à la terre doivent être utilisés pour garantir la conformité de l'organisme aux émissions électromagnétiques (CEM).

- **(ION 7000 and ION 9000 only)** At least two people are recommended for unpacking, handling, and relocating the heavier firewalls.
- Do not connect a supply voltage that exceeds the input range of the firewall or appliance. For details on the electrical range, refer to electrical specifications in the hardware reference for your firewall or appliance.

**French Translation:** Veillez à ce que la tension d'alimentation ne dépasse pas la plage d'entrée du pare-feu ou du dispositif. Pour plus d'informations sur la mesure électrique, consulter la rubrique des caractéristiques électriques dans la documentation de votre matériel de pare-feu ou votre dispositif.

- WAN and LAN ethernet ports are suitable for interconnection to other local device ethernet ports. These ports are not designed for direct connection to Public Switched Telephone Network (PSTN) ports or interfaces. In addition, copper-based WAN ports, LAN ports, and copper-based modular transceivers are not rated to connect to Telecommunications Outside Plant (OSP) cabling.



- **(Devices with serviceable batteries only)** Do not replace a battery with an incorrect battery type; doing so can cause the replacement battery to explode. Dispose of used batteries according to local regulations.

**French Translation:** Ne remplacez pas la batterie par une batterie de type non adapté, cette dernière risquerait d'exploser. Mettez au rebut les batteries usagées conformément aux instructions.

- I/O ports are intended for intra-building connections only and not intended for OSP (Outside Plant) connections or any network connections subject to external voltage surge events.

<ul style="list-style-type: none"><li>• </li></ul>	<p><b>(All Palo Alto Networks appliances with two or more power supplies)</b></p> <p>Caution: Shock hazard</p> <p>Disconnect all power cords (AC or DC) from the power inputs to fully de-energize the hardware.</p> <p><b>French Translation:</b> (Tous les appareils Palo Alto Networks avec au moins deux sources d'alimentation) Débranchez tous les cordons d'alimentation (c.a. ou c.c.) des entrées d'alimentation et mettez le matériel hors tension.</p>
---	---



# ION 5200 Overview

Prisma SD-WAN ION 5200 is a next generation software-defined device that can be deployed in a large branch or a data center. With the introduction of ION 5200, accelerate your SASE deployment to a large branch or a DC by leveraging WAN connectivity without installing additional hardware to enable rapid deployments.

The new high-performance ION 5200 device comes with higher power SFP+ ports to support smart SFPs with speeds 1G/10G, RJ-45 1G ports and RJ-45 1/2.5G ports with PoE to power to power external cellular gateways and other PoE powered devices such as IP phones or cameras or Wireless Access Points.

- [ION 5200 Hardware Specifications](#)
- [ION 5200 Front Panel](#)
- [ION 5200 Back Panel](#)
- [Installation Kit Components](#)
- [ION 5200 Compliance Statement](#)

# ION 5200 Hardware Specifications

Learn the hardware specifications of the ION 5200 device.

Feature	ION 5200
Description	Enterprise large branch and data center.
<b>Ports</b>	
Console Port	1 x RJ-45, UART/Micro USB Type B Console
WAN/LAN ports	Ports 1 - 22 are ethernet ports. By default, all ports are DHCP-enabled, ports 1 and 2 are used to connect to internet. 11 x 1G (RJ45) 10 x 10G/1G (SFP+) 4 x MGig 1G/2.5G (PoE++)
Bypass	Ports 1 - 4 are Bypass pairs (2-pairs, 4 x RJ45)
PoE	Ports 9 - 12 are PoE, MGig ports indicated with a yellow bar between the port numbers, 150W per system, 90W max/port
SFP+ Ports	Ports 13 - 16 are SFP+ 10G/1G ports.
USB	1 x Type-A
Flash Storage	240GB NVMe SSD drive
Encrypted IP throughput	Measured with 1400 byte packets - 4Gbps at DC, 2Gbps at Branch Measured with 600 byte packets - 1.5Gbps at DC, 1Gbps at Branch
Memory	32GB
Power Supply	2 plug-in 450 Wat, AC 100–240 V, 50–60Hz
Redundant Power Supply	Yes (FRU RPS), Hot swappable
<b>Mechanical</b>	
System Cooling	Forced Air, 5 Fans.

Feature	ION 5200
	The airflow direction is from the front (network ports) to the rear (power supplies) of the device.
<b>Certifications</b>	
Certifications	IEC 60950-1, cULus, FCC & CE Class A, BIS, CCC, KCC
<b>Environmental</b>	
Operating temperature (3000 m altitude)	32°F - 104°F (0°C - 40°C)
Storage temperature	-4°F - 158°F (-20°C - 70°C)
Operating humidity (non-condensing)	5-90%
Storage humidity (non-condensing)	5-95%
<b>Physical</b>	
Dimensions	14.15" x 17.15" x 1.70"
Weight (lbs)	15
Mount options	Four-post Rack

## ION 5200 Front Panel

The following table describes the front panel components of the ION 5200.

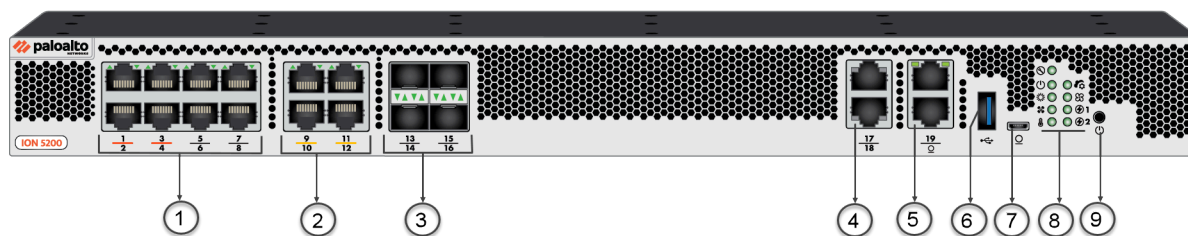

Item	Component	Description
1	Bypass Pair	Ports 1 - 4 are Bypass pairs, 4 x 1G RJ45.
2	PoE Ports	Ports 9 - 12 are PoE MGig ports capable of 1G/2.5G.
3	SFP+ ports	Ports 13 - 16 are SFP+ (10G) ports and also supports 1G SFP.
4	RJ-45 Ports	Ports 5 - 8, 17-19 are RJ-45 10M/100M/1000M ethernet ports.
5	Console Port	RJ-45 Serial console port. Use this port to connect a management computer to the device using a 9-pin serial-to-RJ-45 cable.
6	Standard USB	USB Port. A USB port that accepts a USB flash drive.
7	Micro USB Port	Micro USB Console Port. Use this port to connect a management computer to the device using a standard Type-A USB-to-micro USB cable.
8	LED Indicators	LEDs indicate the status of the ION device components.
9	Power/Reset	Power LED; the LED turns green when powered on.

## ION 5200 Back Panel

The following table describes the back panel components of the ION 5200.

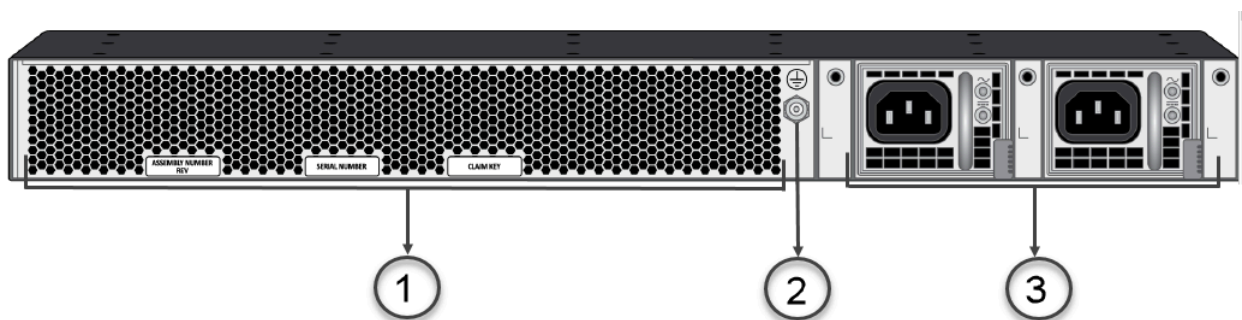

Item	Component	Description
1	Fan Exhaust	Provides ventilation and cooling for the device.   <i>The fans are not field replaceable.</i>
2	Ground stud	Use the single post ground stud to connect the firewall to earth ground (ground cable not included).
3	PS1 and PS2	Use the power supply inputs to connect AC power to the ION 5200. The second power supply is for redundancy. When facing the back of the device, PS1 is on the left and PS2 is on the right.

## Installation Kit Components







The ION 5200 device installation kit contains the following parts and tools to install the device:



- 1x ION 5200 device ships with 2x 450W built in PSU.
- 1x power cord, AC, which varies depending on the country or region.
- 1x USB 2.0 to RJ45 Console cable.
- 1x Shielded RJ-45 CAT6 Ethernet cable.
- 1x Velcro
- 1x Rack mount kit.
  - 2x 1RU mounting ears (left and right)
  - 2x Adjustable 1RU mounting brackets (left and right)
  - 2x Rear support brackets
  - 13x #6-32 x 5/16" rack-mount screws
  - 9x #10-32 x 3/4" rack-mount screws
  - 9x #12-24 x 1/2" rack-mount screws
  - 8x #10-32 nut cages
- China RoHS Declaration
- End User License Agreement (EULA)



## ION 5200 LEDs

Refer to the ION 5200 device front panel images for position of the LEDs on the ION 5200 devices and its description.

LEDs	ION 5200
Service 	<ul style="list-style-type: none"> <li>Blue LED indicates the device is in Service mode.</li> <li>Off LED indicates that the device is not in Service mode.</li> </ul>
Power 	<ul style="list-style-type: none"> <li>Green LED indicates the device is powered on.</li> <li>Red LED indicates that the device is not getting enough power.</li> <li>Off LED indicates that the device is powered off.</li> </ul>
Operating System Status 	<ul style="list-style-type: none"> <li>Green LED indicates OS is running.</li> <li>Red LED indicates secure boot has failed.</li> </ul>
Controller 	<ul style="list-style-type: none"> <li>Green LED indicates that the device is connected to the controller.</li> <li>Red LED indicates the device is attempting to connect to the controller.</li> <li>Off LED indicates that the device is not attempting to connect to the controller.</li> </ul>
HA 	<ul style="list-style-type: none"> <li>Green LED indicates that the device is Active.</li> <li>Yellow LED indicates the device is on standby mode.</li> <li>Off LED indicates that the device is not HA configured.</li> </ul>
Temperature 	<ul style="list-style-type: none"> <li>Green—Link detected and speed is 100Mbps.</li> <li>Red—Link detected and speed is 1Gbps.</li> </ul>
PSU 1 	<ul style="list-style-type: none"> <li>Off—LED indicates that the PSU is not present.</li> <li>Green—LED indicates that the PSU is active and good.</li> <li>Red—LED indicates that the PSU is not active.</li> </ul>
PSU 2	<ul style="list-style-type: none"> <li>Off—LED indicates that the PSU is not present.</li> <li>Green—LED indicates that the PSU is active and good.</li> <li>Red—LED indicates that the PSU is not active.</li> </ul>

LEDs	ION 5200
	
<p>FAN</p> 	<ul style="list-style-type: none"> <li>• Green—LED indicates that the FAN is running good.</li> <li>• Red—LED indicates that the FAN service is required.</li> </ul>
<p>Link/Speed/Activity (PHY controlled)</p>	<p>10G SFP+Ports</p> <ul style="list-style-type: none"> <li>• Speed and Activity LED- Yellow (1Gbps) or Green (10Gbps).</li> </ul> <p>1G/MGiG RJ45 Ports</p> <ul style="list-style-type: none"> <li>• Activity LED- Green ON/blinking.</li> </ul>

## ION 5200 Compliance Statement

The following compliance statements apply to this ION device:

- **VCCI**—This section provides the compliance statement for the Voluntary Control Council for Interference by Information Technology Equipment (VCCI), which governs radio frequency emissions in Japan.

The following information is in accordance to VCCI Class A requirements:

この装置は、クラスA情報技術装置です。この装置を家庭環境で使用すると電波妨害を引き起こすことがあります。この場合には使用者が適切な対策を講ずるよう要求されることがあります。 VCCI-A

**Translation:** This is a Class A product. In a domestic environment this product may cause radio interference, in which case the user may be required to take corrective actions.

- **UL**—Product Ambient Temperature: 0~40 degree C



*Risk of explosion if battery is replaced by an incorrect type. Dispose of used battery according to local regulations.*

- **CE (European Union (EU) Electromagnetic Compatibility Directive)**

The ION device is in conformity with the harmonized standards and fulfills the essential requirements of the LVD Directive 2014/35/EU, EMC Directive 2014/30/EU, WEEE Directive 2012/19/EU, and RoHS Directives 2011/65/EU and 2015/863/EU.

The device complies with the requirements relating to electrical equipment designed for use within certain voltage limits.

- **United Kingdom Declaration of Conformity (UKCA) Directives**

The ION device is in conformity with the designated standards and fulfills the requirements of the Electrical Equipment (Safety) Regulations 2016, Electromagnetic Compatibility Regulations 2016, and The Restriction of the Use of Certain Hazardous Substances in Electrical and Electronic Equipment Regulations 2012.

- **Federal Communications Commission (FCC) statement for a Class A digital device or peripheral**—This equipment has been tested and found to comply with the limits for a Class A digital device, pursuant to Part 15 of the FCC Rules. These limits are designed to provide reasonable protection against harmful interference in a residential installation. This equipment generates, uses, and can radiate radio frequency energy and, if not installed and used in accordance with the instructions, may cause harmful interference to radio communications. However, there is no guarantee that interference will not occur in a particular installation. If this equipment does cause harmful interference to radio or television reception, which can be

determined by turning the equipment off and on, the user is encouraged to try to correct the interference by one or more of the following measures.

- Reorient or relocate the receiving antenna.
- Increase the separation between the equipment and receiver.
- Connect the equipment to an outlet on a circuit that is different from the one to which the receiver is connected.
- Consult the dealer or an experienced radio/TV technician for help.
- **ICES (Canadian EMC Compliance Statement)**—This Class A digital apparatus complies with Canadian ICES-003.

**French translation:** Cet appareil numérique de la classe A est conforme à la norme NMB-003 du Canada.

- **Korean Communications Commission (KCC) Class A Statement**—This equipment is an electromagnetic compatible device for business purposes (Class A). The provider or user should be aware that the equipment is intended for use outside the home.

- **Taiwan Declaration of the Presence Condition of the Restricted Substances Marking.**

## 限用物質含有情況標示聲明書

Declaration of the Presence Condition of the Restricted Substances Marking

證書號碼 / 受理編號: (No.) 新申請

商品標籤及商品檢驗標識: (Picture)

Certificate No./ Application No.

樣張及其標示位置: (Description and Picture)

Product Label and Commodity Inspection Mark.

設備名稱: 網路服務器		, 型號 (型式): ion 3000				
Equipment Name		Type designation (Type)				
單元 Unit	限用物質及其化學符號 Restricted substances and its chemical symbols					
	鉛Lead (Pb)	汞Mercury (Hg)	鎘Cadmium (Cd)	六價鉻Hexavalent chromium (Cr <sup>VI</sup> )	多溴聯苯Polybrominated biphenyls (PBB)	多溴二苯醚Polybrominated diphenyl ethers (PBDE)
內部電源供應器 POWER SUPPLY	-	○	○	○	○	○
輸出/裝置 I/O	○	○	○	○	○	○
固態硬碟HDD	○	○	○	○	○	○
儲存裝置 FLASH DISK	○	○	○	○	○	○
風扇 FAN	-	○	○	○	○	○
金屬機構件 ME metal part	○	○	○	○	○	○
塑膠機構件 ME plastic part	○	○	○	○	○	○
配件(例: 電源線 等) Accessory (ex: cable, etc.)	○	○	○	○	○	○
印刷電路板元件 PCBA	-	○	○	○	○	○
<p>這是甲類的資訊產品, 在居住的環境中使用時, 可能會造成射頻干擾, 在這種情況下, 使用者會被要求採取某些適當的對策。</p> <p>如果將鋰電池更換成錯誤類型的電池, 會有爆炸的危險。電池只能更換為與製造商建議相同或等同類型的電池。</p> <p>備考1. “超出0.1 wt %” 及 “超出0.01 wt %” 係指限用物質之百分比含量超出百分比含量基準值。</p> <p>Note 1: “Exceeding 0.1 wt %” and “exceeding 0.01 wt %” indicate that the percentage content of the restricted substance exceeds the reference percentage value of presence condition.</p> <p>備考2. “○” 係指該項限用物質之百分比含量未超出百分比含量基準值。</p> <p>Note 2: “○” indicates that the percentage content of the restricted substance does not exceed the percentage of reference value of presence.</p> <p>備考3. “-” 係指該項限用物質為排除項目。</p> <p>Note 3: The “-” indicates that the restricted substance corresponds to the exemption.</p>						

- **NCC (Nigerian Communications Commission)**

Connection and use of this communications equipment is permitted by the Nigerian Communications Commission (NCC)

## Power on the ION

Connect the power cables to the ION device and plug the device power cable into an AC power outlet. When you switch on the power, the device powers on and the power indicator turns green.

## Restart the ION 5200

Press the power switch three times (press and hold for one second, and then release) to restart the device.

## Shut Down the ION 5200

Shut down the ION 5200 in the following ways:

- **Shut down using the Device Toolkit commands**

Run the device toolkit command `debug shutdown` to shut down the device.



*Ensure the device is physically accessible to turn it back on, before executing the command.*

- **Shut down using the Power Switch**

Press the power switch for more than five to eight seconds and then release to shut down the ION 5200 device.

When you shut down the device using the device CLI toolkit command or the power switch, click the power switch once to power on the device.



# Install the ION 5200

The ION 5200 ships with rack-mount brackets for installation in a four-post 19" equipment rack. Learn how to install the device using the four-post rack mount kit.

- [Install the ION 5200 Using the Four-Post Rack Mount Kit](#)

# Install the ION 5200 Using the Four-Post Rack Mount Kit

The following procedure describes how to install the ION 5200 in a 19" four-post equipment rack using the four-post rack kit.

**STEP 1 |** Attach one rack-mount bracket to each side of the ION 5200 in the front-mount position using four #6-32 x 5/16" screws for each bracket and torque to 9 in-lbs.

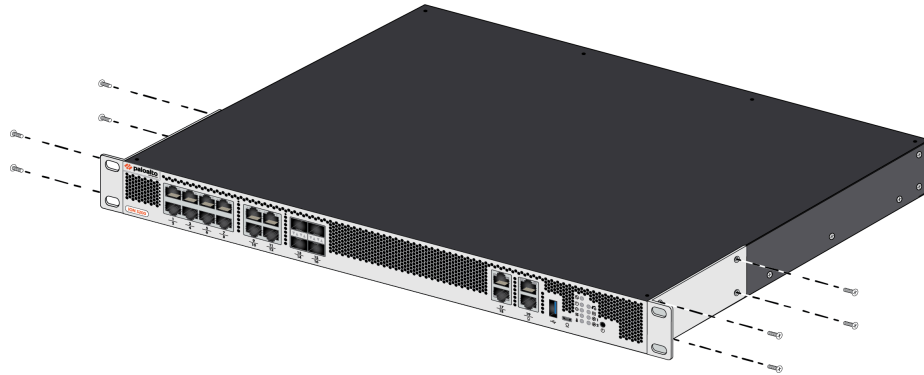

**STEP 2 |** Attach one rack-mount rail to each side of the device using two #6-32 x 5/16" screws for each rail and torque to 9 in-lbs.

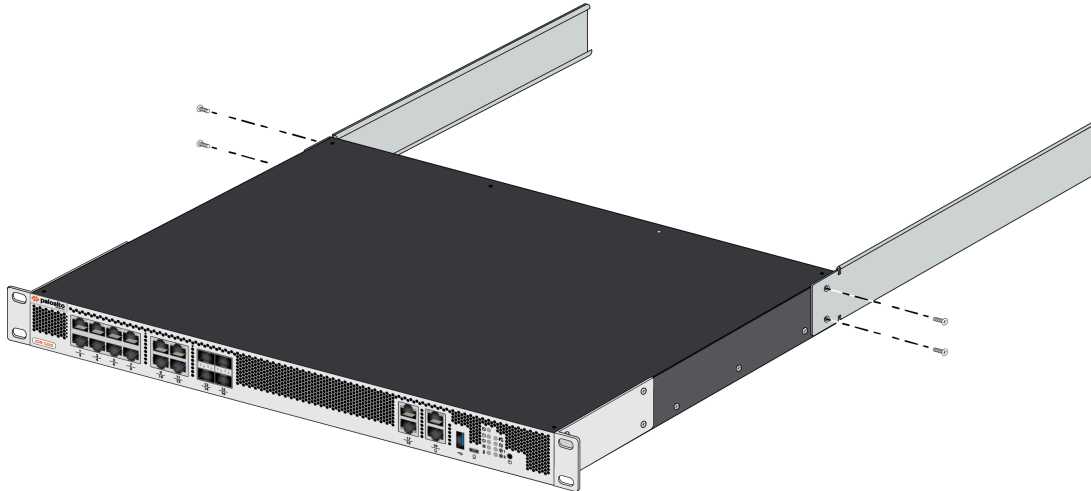

**STEP 3 |** Hold the device in the rack and secure the front rack-mount brackets to the front rack-posts using two screws for each bracket. Use the appropriate screws (#10-32 x 3/4" or #12-24 x

1/2") for your rack and torque to 25 in-lbs. Use cage nuts to secure the screws if the rack has square holes.

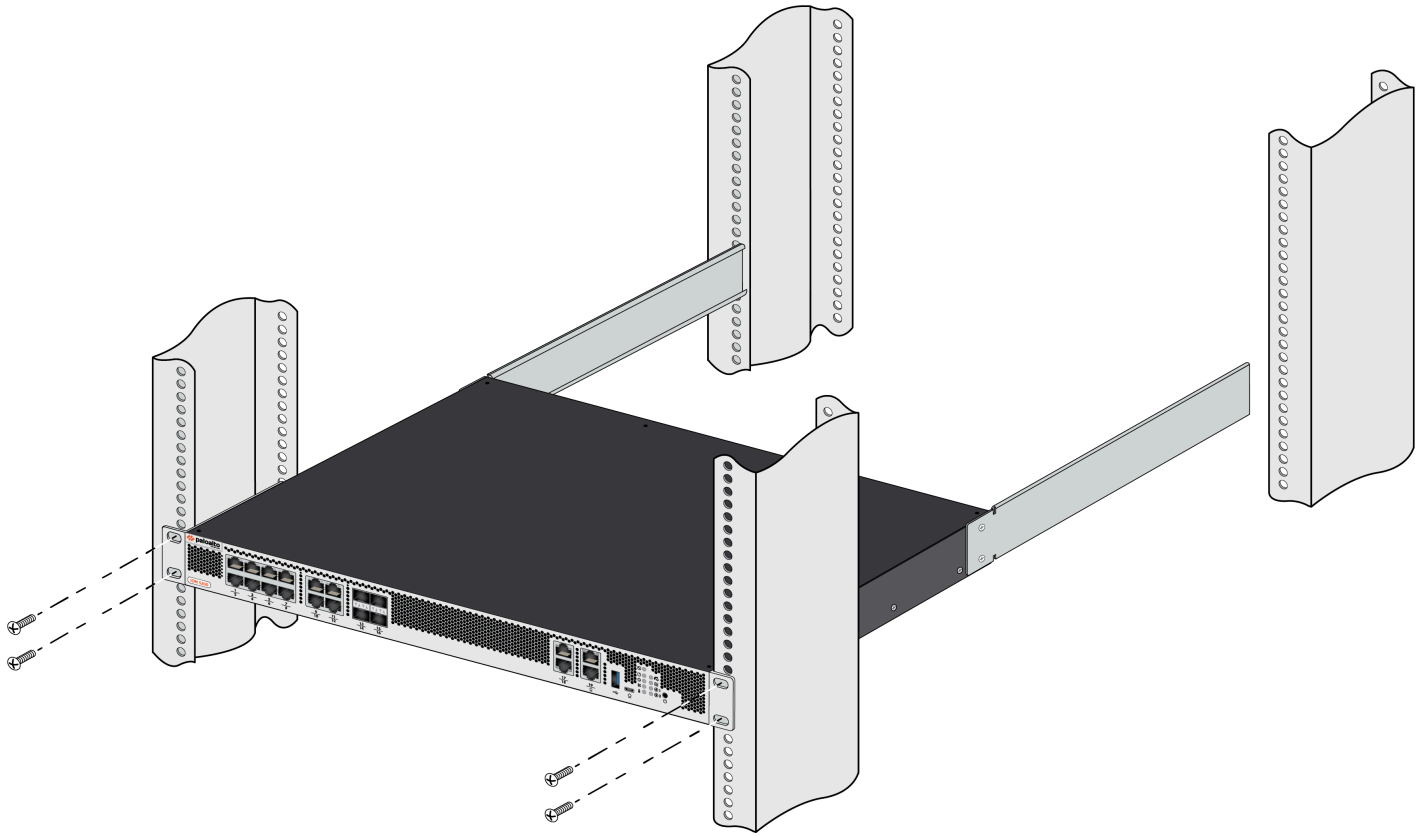

**STEP 4 |** Slide one back rack-mount bracket into each of the two previously installed side rack-mount rails and secure the brackets to the back rack-posts using the appropriate screws for your rack (#10-32 x 3/4" or #12-24 x 1/2") and torque to 25 in-lbs.

